

**Characteristics**

**Material**

- Sheet Steel (EN 10130 DC01)
- Body : 1.5 mm
- Door : 1.5 mm
- Galvanized Steel (EN 10346 DX51D+Z)
- Mounting plate : 2 mm

**Surface Finishing**

- RAL7035w powder coating

**IP Rating**

- Single door enclosures
- IP65 (TS 3033, EN 60529)
- Double door enclosures
- IP55 (TS 3033, EN 60529)

**Others**

- Fully welded construction
- Solid door
- Foamed-in door PU sealing gasket
- Bottom gland plate

**On Request**

- Special sizes
- Special colour
- Pre-punching

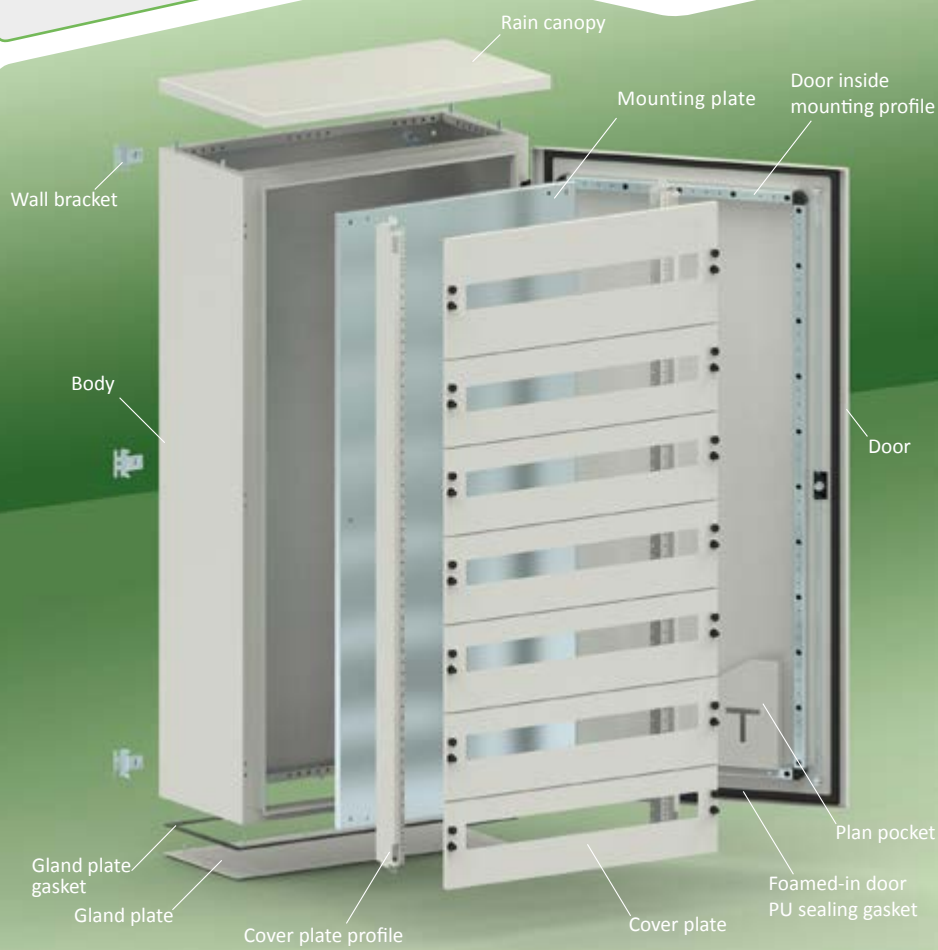

**Supply Includes**

- Body
- Door
- Rain canopy
- Mounting plate
- 4/6 pcs wall brackets
- Gland plate with gasket

**Complementary Accessories**

- Support base
- Cover plate and profiles
- Standoff
- Door inside mounting profile
- Plan pocket
- Special locks and keys
- Earthing cable
- Plastic cover plate

| Width<br>A | Height<br>B | Depth<br>C | Reference  | Door<br>pcs | Hinge<br>pcs | Wall<br>Bracket<br>pcs | Door Useful Area |         | Gland Plate |         |         | Wall<br>Mounting |         | Mounting Plate |         |
|------------|-------------|------------|------------|-------------|--------------|------------------------|------------------|---------|-------------|---------|---------|------------------|---------|----------------|---------|
|            |             |            |            |             |              |                        | ↔<br>mm          | ↕<br>mm | pcs         | ↔<br>mm | ↕<br>mm | ↔<br>mm          | ↕<br>mm | ↔<br>mm        | ↕<br>mm |
| 600        | 1200        | 250        | EDT 061225 | 1           | 3            | 6                      | 420              | 1020    | 1           | 560     | 113     | 644              | 1089    | 496            | 1116    |
|            |             | 300        | EDT 061230 | 1           | 3            | 6                      | 420              | 1020    | 1           | 560     | 203     | 644              | 1089    | 496            | 1116    |
|            | 1400        | 250        | EDT 061425 | 1           | 3            | 6                      | 420              | 1220    | 1           | 560     | 113     | 644              | 1289    | 496            | 1316    |
|            |             | 300        | EDT 061430 | 1           | 3            | 6                      | 420              | 1220    | 1           | 560     | 203     | 644              | 1289    | 496            | 1316    |
| 800        | 1200        | 250        | EDT 081225 | 1           | 3            | 6                      | 620              | 1020    | 1           | 760     | 113     | 844              | 1089    | 696            | 1116    |
|            |             | 300        | EDT 081230 | 1           | 3            | 6                      | 620              | 1020    | 1           | 760     | 203     | 844              | 1089    | 696            | 1116    |
|            | 1400        | 250        | EDT 081425 | 1           | 3            | 6                      | 620              | 1220    | 1           | 760     | 113     | 844              | 1289    | 696            | 1316    |
|            |             | 300        | EDT 081430 | 1           | 3            | 6                      | 620              | 1220    | 1           | 760     | 203     | 844              | 1289    | 696            | 1316    |
| 1000       | 1200        | 250        | EDT 101230 | 2           | 6            | 6                      | 320 + 320        | 1020    | 1           | 960     | 203     | 1044             | 1089    | 896            | 1116    |
|            |             | 300        | EDT 101430 | 2           | 6            | 6                      | 320 + 320        | 1220    | 1           | 960     | 203     | 1044             | 1289    | 896            | 1316    |
|            | 1400        | 250        | EDT 081625 | 1           | 3            | 6                      | 620              | 1420    | 1           | 760     | 113     | 844              | 1489    | 696            | 1516    |
|            |             | 300        | EDT 081625 | 1           | 3            | 6                      | 620              | 1420    | 1           | 760     | 113     | 844              | 1489    | 696            | 1516    |

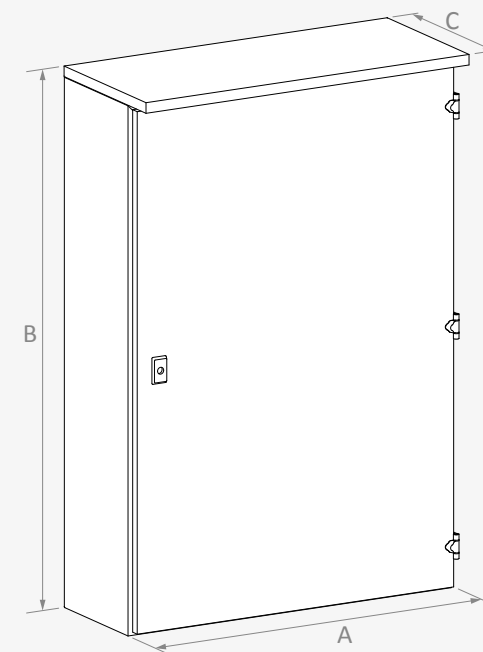

**DOOR USEFUL AREA**

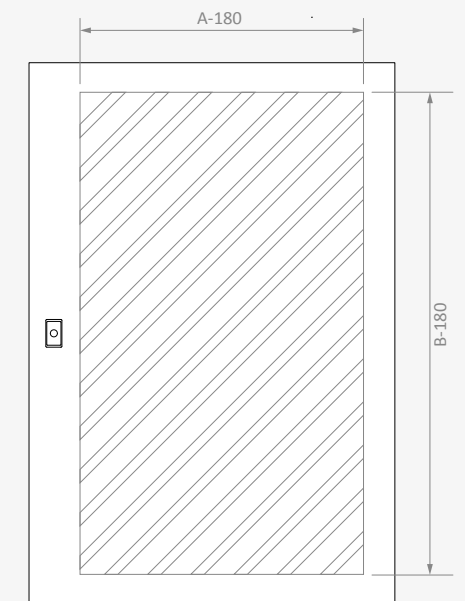

**WALL MOUNTING**

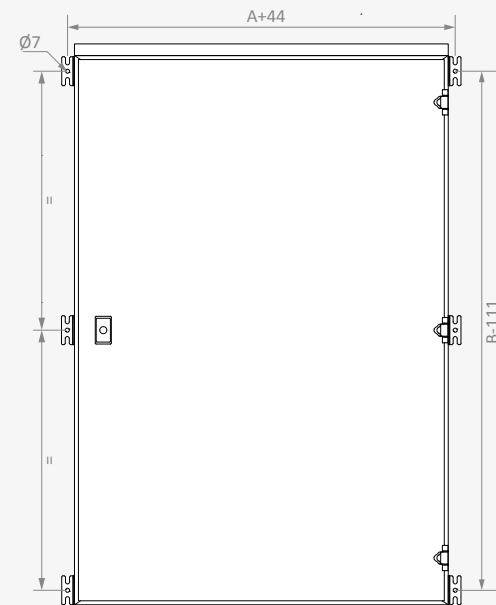

**MOUNTING PLATE**

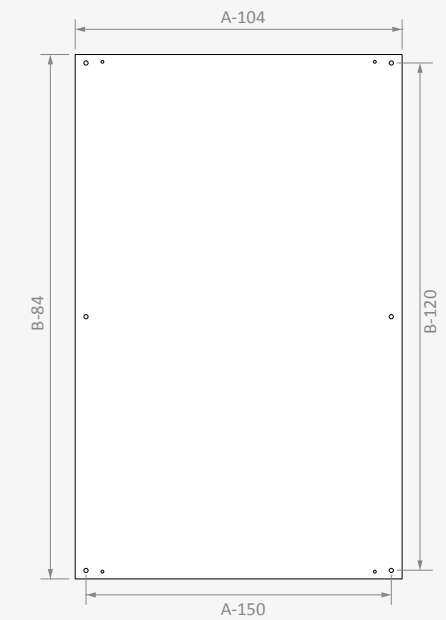

SOLID DOOR

| Reference   | Width   |         | Height    |         | Wide      |          | Length |   | Useful Area |   | Door<br>pcs | Lock Type<br>* | Lock<br>pcs | Hinge<br>pcs | Weight<br>kg |
|-------------|---------|---------|-----------|---------|-----------|----------|--------|---|-------------|---|-------------|----------------|-------------|--------------|--------------|
|             | A<br>mm | B<br>mm | X<br>mm   | Y<br>mm | W1<br>mm  | H1<br>mm |        |   |             |   |             |                |             |              |              |
| EDT KP 0612 | 600     | 1200    | 583       | 1158    | 420       | 1020     | 1      | I | 1           | 3 | 8.1         |                |             |              |              |
| EDT KP 0614 | 600     | 1400    | 583       | 1358    | 420       | 1220     | 1      | I | 1           | 3 | 9.5         |                |             |              |              |
| EDT KP 0616 | 600     | 1600    | 583       | 1558    | 420       | 1420     | 1      | I | 1           | 3 | 10.8        |                |             |              |              |
| EDT KP 0812 | 800     | 1200    | 783       | 1158    | 620       | 1020     | 1      | I | 1           | 3 | 10.8        |                |             |              |              |
| EDT KP 0814 | 800     | 1400    | 783       | 1358    | 620       | 1220     | 1      | I | 1           | 3 | 12.7        |                |             |              |              |
| EDT KP 0816 | 800     | 1600    | 783       | 1558    | 620       | 1420     | 1      | I | 1           | 3 | 14.6        |                |             |              |              |
| EDT KP 1012 | 1000    | 1200    | 489 + 489 | 1158    | 320 + 320 | 1020     | 2      | I | 1           | 3 | 13.5        |                |             |              |              |
| EDT KP 1014 | 1000    | 1400    | 489 + 489 | 1358    | 320 + 320 | 1220     | 2      | I | 1           | 3 | 15.9        |                |             |              |              |

Characteristics

- Material: DIN EN 10130 DC01 CCRS
- Surface Finishing: RAL7035w powder coating
- Thickness: 1.5 mm

Supply Includes

- Lock
- Double door gutter gasket
- I: Escutcheon Rod-latch

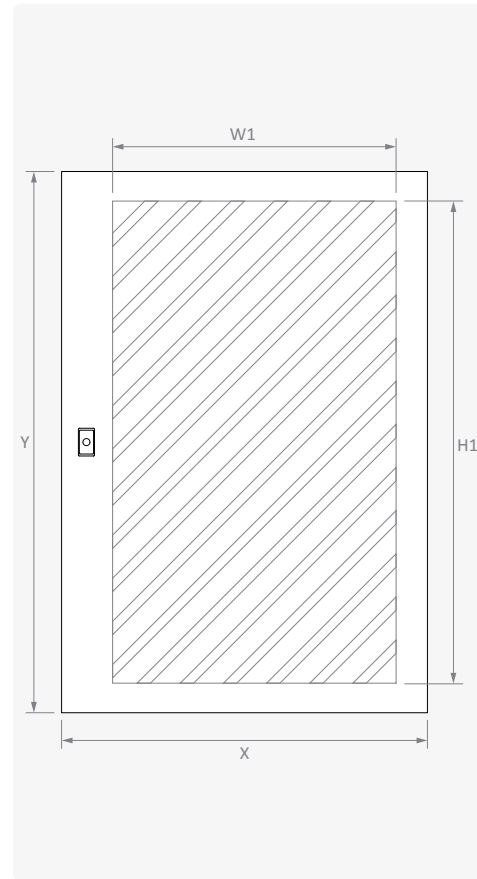

MOUNTING PLATE

| Reference   | Width   |         | Height   |          | External Dimensions |          |          | Mounting Dimensions |      |  | Weight<br>kg |
|-------------|---------|---------|----------|----------|---------------------|----------|----------|---------------------|------|--|--------------|
|             | A<br>mm | B<br>mm | X1<br>mm | Y1<br>mm | Z<br>mm             | X2<br>mm | Y2<br>mm | D<br>mm             |      |  |              |
| EDT TS 0612 | 600     | 1200    | 496      | 1116     | 15                  | 450      | 1080     | M8                  | 8.8  |  |              |
| EDT TS 0614 | 600     | 1400    | 496      | 1316     | 15                  | 450      | 1280     | M8                  | 10.4 |  |              |
| EDT TS 0616 | 600     | 1600    | 496      | 1516     | 15                  | 450      | 1480     | M8                  | 12   |  |              |
| EDT TS 0812 | 800     | 1200    | 696      | 1116     | 15                  | 650      | 1080     | M8                  | 12.4 |  |              |
| EDT TS 0814 | 800     | 1400    | 696      | 1316     | 15                  | 650      | 1280     | M8                  | 14.6 |  |              |
| EDT TS 0816 | 800     | 1600    | 696      | 1516     | 15                  | 650      | 1480     | M8                  | 16.8 |  |              |
| EDT TS 1012 | 1000    | 1200    | 896      | 1116     | 15                  | 850      | 1080     | M8                  | 15.9 |  |              |
| EDT TS 1014 | 1000    | 1400    | 896      | 1316     | 15                  | 850      | 1280     | M8                  | 18.8 |  |              |

Characteristics

- Material: DIN EN 10346 DX51D+Z galvanized
- Thickness: 2 mm

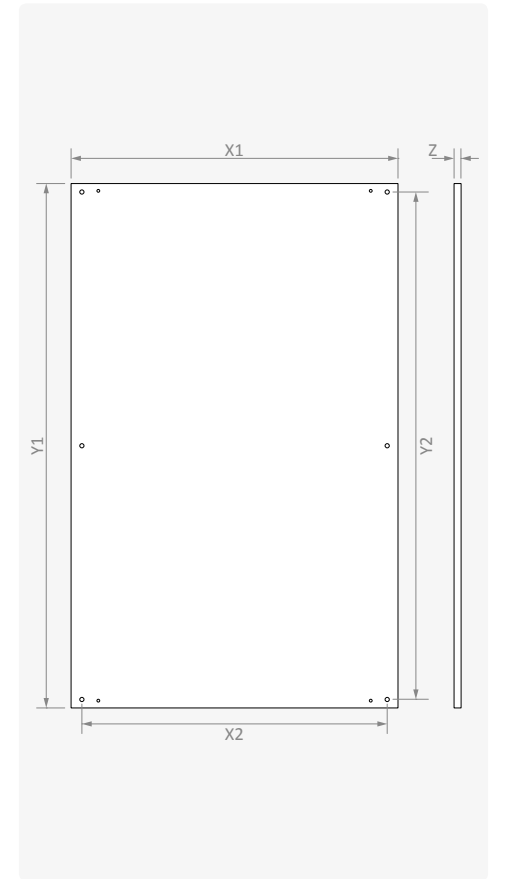

CABLE GLAND PLATE

| Reference   | Width   |         | Depth    |          | External Dimensions |          | Useful Area |  | Weight<br>kg |
|-------------|---------|---------|----------|----------|---------------------|----------|-------------|--|--------------|
|             | A<br>mm | C<br>mm | X1<br>mm | Z1<br>mm | X2<br>mm            | Z2<br>mm |             |  |              |
| ETS GP 6020 | 600     | 250     | 590      | 146      | 560                 | 113      | 1.1         |  |              |
| ETS GP 6030 | 600     | 300     | 590      | 246      | 560                 | 193      | 1.8         |  |              |
| ETS GP 8020 | 800     | 250     | 790      | 146      | 760                 | 113      | 1.4         |  |              |
| ETS GP 8030 | 800     | 300     | 790      | 246      | 760                 | 193      | 2.4         |  |              |
| ETS GP 1030 | 1000    | 300     | 990      | 246      | 960                 | 193      | 3.0         |  |              |

**Characteristics**

- Material: DIN EN 10130 DC01 CCRS
- Surface Finishing: RAL7035w powder coating
- Thickness: 1.5 mm

**Supply Includes**

- One piece PE gasket
- Mounting fasteners

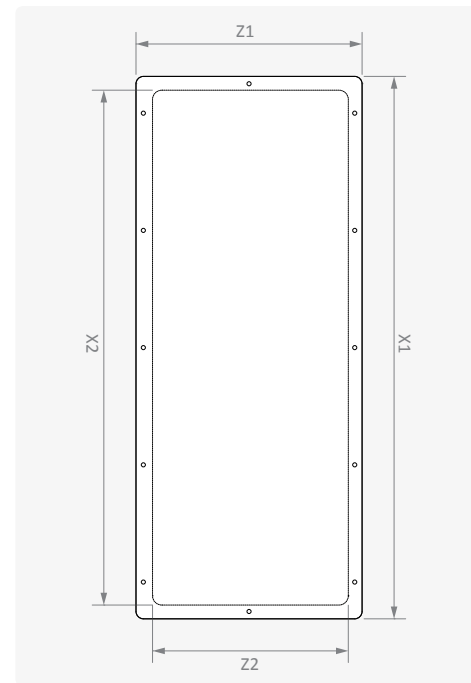

MOUNTING PROFILE INSIDE DOOR

| Reference  | Condition  | Width |      | Height | Length | Weight<br>kg |
|------------|------------|-------|------|--------|--------|--------------|
|            |            | A     | B    | B      | Y1     |              |
| ASKUY00600 | Horizontal | 600   | -    | -      | 420    | 0.3          |
| ASKUY00800 | Horizontal | 800   | -    | -      | 620    | 0.5          |
| ASKUD01000 | Horizontal | 1000  | -    | -      | 820    | 0.6          |
| ASKUD01200 | Vertical   | -     | 1200 | -      | 1020   | 0.7          |
| ASKUDRM130 | Vertical   | -     | 1400 | -      | 1220   | 9.0          |
| ASKUD01600 | Vertical   | -     | 1600 | -      | 1420   | 1.0          |

**Characteristics**

- Material: 20x20 square profile galvanized
- Thickness: 1.2 mm

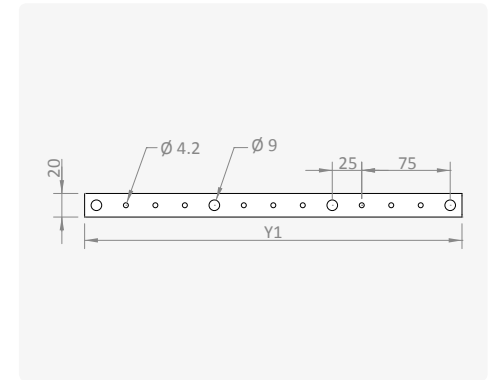

COVER PLATE PROFILE

| Reference  | Height  | External Dimensions<br>Y<br>mm | Packet<br>pcs/packet | Weight<br>kg |
|------------|---------|--------------------------------|----------------------|--------------|
|            | B<br>mm |                                |                      |              |
| EKO PR 120 | 1200    | 1150                           | 2                    | 3.0          |
| EKO PR 140 | 1400    | 1350                           | 2                    | 3.6          |
| EKO PR 160 | 1600    | 1550                           | 2                    | 4.1          |

**Characteristics**

- Material: DIN EN 10130 DC01 CCRS
- Surface Finishing: RAL7035w powder coating
- Thickness: 1.2 mm

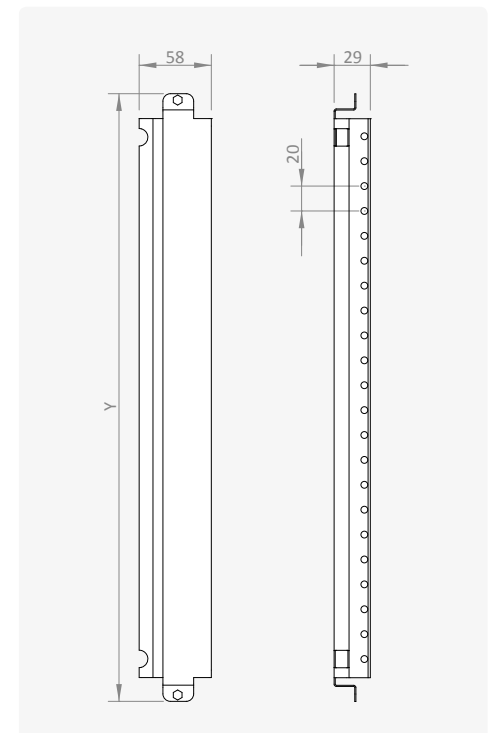

PLAN POCKETS

| Reference | Width          |          | Length   |          |     | Weight<br>kg |
|-----------|----------------|----------|----------|----------|-----|--------------|
|           | A<br>mm        | X1<br>mm | Y1<br>mm | Z1<br>mm |     |              |
| AS PJ 040 | All Dimensions | A4       | 200      | 30       | 0.4 |              |
| AS PJ 060 | 600/1200       | A3       | 240      | 60       | 1.9 |              |
| AS PJ 080 | 800            | A3       | 240      | 60       | 2.6 |              |

**Characteristics**

- Material: DIN EN 10130 DC01 CCRS
- Surface Finishing: RAL7035w powder coating
- Thickness: 1.5 mm

**Supply Includes**

- Mounting fasteners to fix door reinforcement frame

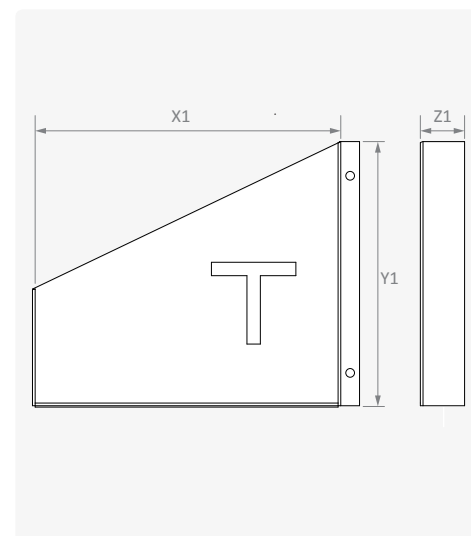
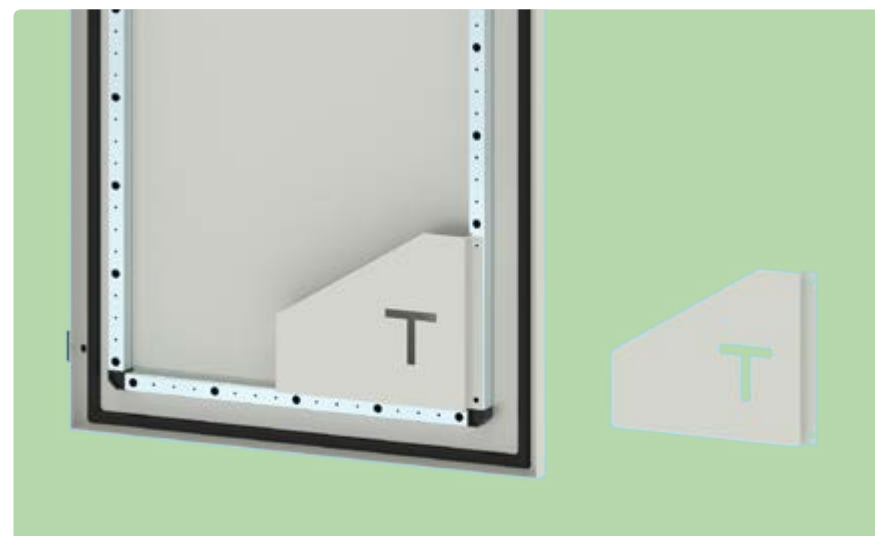

STANDARD COVER PLATE SET

| Reference   | Width |      | Cover Plate Quantity | Capacity | Module Cut-Out |        | Solid Cover Plate |        |        |        |
|-------------|-------|------|----------------------|----------|----------------|--------|-------------------|--------|--------|--------|
|             | A     | B    |                      |          | Height         | Height | Height            | Height | Height | Height |
|             | mm    | mm   | pcs                  | Module   | 120            | 160    | 100               | 120    | 140    | 160    |
| EDT PT 0612 | 600   | 1200 | 8                    | 174      | 1              | 5      |                   | 1      | 1      |        |
| EDT PT 0614 | 600   | 1400 | 9                    | 203      |                | 7      |                   | 1      | 1      |        |
| EDT PT 0616 | 600   | 1600 | 10                   | 232      |                | 8      |                   |        | 1      | 1      |

| Characteristics   |                         | Supply Includes                     |
|-------------------|-------------------------|-------------------------------------|
| Material          | DIN EN 10130 DC01 CCRS  | Cover plates / Cover plate profiles |
| Surface Finishing | RAL7035w powder coating | Cover plate profile fasteners       |

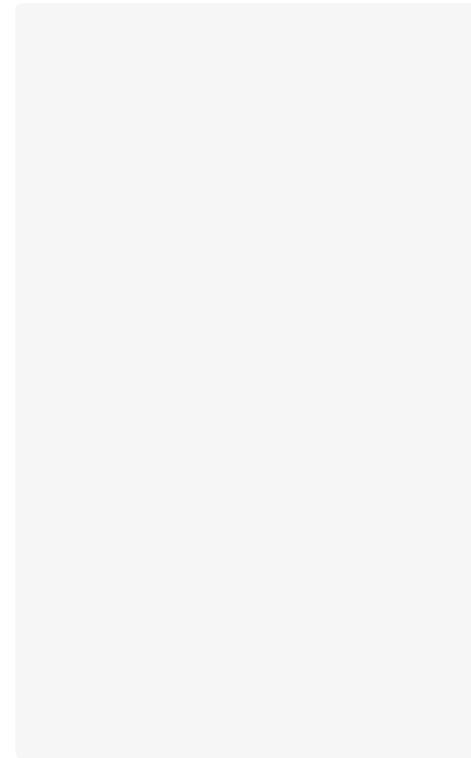

COVER PLATES

| Reference    | Width | External Dimensions |     | Useful Area | Module Cut-Out    |                   | Weight |
|--------------|-------|---------------------|-----|-------------|-------------------|-------------------|--------|
|              |       | X1                  | Y1  |             | X3                | Capacity Module * |        |
| A            | X1    | Y1                  | X2  | X3          | Capacity Module * | kg                |        |
| ETS PL 6010  | 600   | 568                 | 98  | 525         | -                 | -                 | 0.5    |
| ETS PL 6012  | 600   | 568                 | 118 | 525         | -                 | -                 | 0.6    |
| ETS PL 6014  | 600   | 568                 | 138 | 525         | -                 | -                 | 0.6    |
| ETS PL 6016  | 600   | 568                 | 158 | 525         | -                 | -                 | 0.8    |
| ETS PL 6012W | 600   | 568                 | 118 | -           | 515               | 29                | 0.4    |
| ETS PL 6016W | 600   | 568                 | 158 | -           | 515               | 29                | 0.6    |

| Characteristics   |                         | Supply Includes                                 |
|-------------------|-------------------------|---|
| Material          | DIN EN 10130 DC01 CCRS  | Cover plate profiles fasteners and plastic nuts |
| Surface Finishing | RAL7035w powder coating | Handles   |
| Thickness         | 0.9 mm                  |   |

